



Glow+

SALICE



Glow+ è un sistema di scorrimento per armadi a 2, 3 o più ante sovrapposte, dotato di un rivoluzionario ammortizzatore magnetico che permette un movimento decelerato sia in apertura sia in chiusura, fluido e particolarmente silenzioso.

L'innovativa soluzione garantisce, infatti, la definitiva eliminazione della rumorosità in apertura e in chiusura e consente una maggiore facilità di apertura, annullando la tipica resistenza dei sistemi a molla.

Glow+ può essere utilizzato con ante in legno e alluminio, con un peso massimo di 70 kg. Il sistema può, tuttavia, essere fornito con un kit di potenziamento, con il quale è possibile utilizzare ante con un peso fino a 100 kg.

L'installazione di Glow+ è alquanto semplice e intuitiva, realizzabile o con viti o automaticamente con l'ausilio di clip con montaggio a pressione.

Il sistema, inoltre, può essere dotato di una copertura magnetica che consente un ulteriore arricchimento estetico.

Glow+ trova diverse applicazioni, in particolare armadi per zona living e notte.





Informazioni tecniche

COMPOSIZIONE MECCANISMO

- Profili in alluminio: lega 6060T5, anodizzati argento.
- Ruote di scorrimento: cuscinetti per alta velocità.
- Carrelli superiori e inferiori: lamiera verniciata.
- Componenti interni: materiale plastico e zama.

CARATTERISTICHE ANTE

- Peso massimo per singola anta 70 kg.
Con kit di potenziamento 100 kg (uniformemente distribuito).
- Spessore suddiviso in 6 categorie:
 - 1: fino a 23 mm;
 - 2: fino a 26 mm;
 - 3: fino a 30 mm;
 - 4: fino a 35 mm;
 - 5: fino a 40 mm;
 - 6: fino a 50 mm.
- Altezza da terra: 17 mm o 33 mm.
- Materiale:
 - a) legno o derivati;
 - b) telaio in metallo e vetro.
- Larghezza minima per l'applicazione dell'ammortizzatore:
 - 2 ante 600 mm;
 - 3 ante 830 mm;
 - 2 e 3 ante con kit di potenziamento 1000 mm.
- Regolazione dell'anta: verticale +5/-0 mm.

TIPOLOGIE APERTURE

- Glow+ è disponibile a una, due, tre o più ante, ciascuna ammortizzata sia in apertura sia in chiusura.

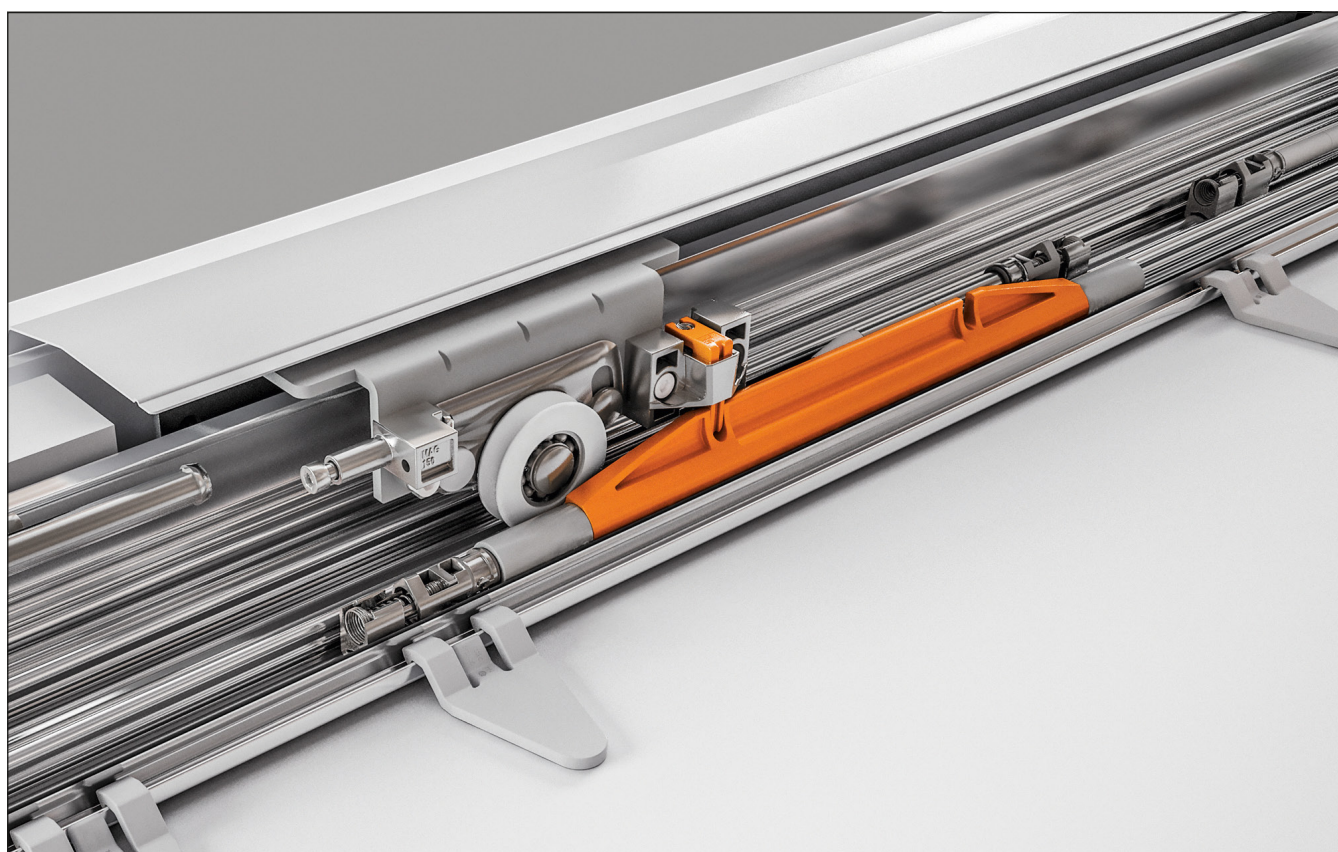

Caratteristiche principali

Innovativo ammortizzatore ad azione magnetica fluido e silenzioso.

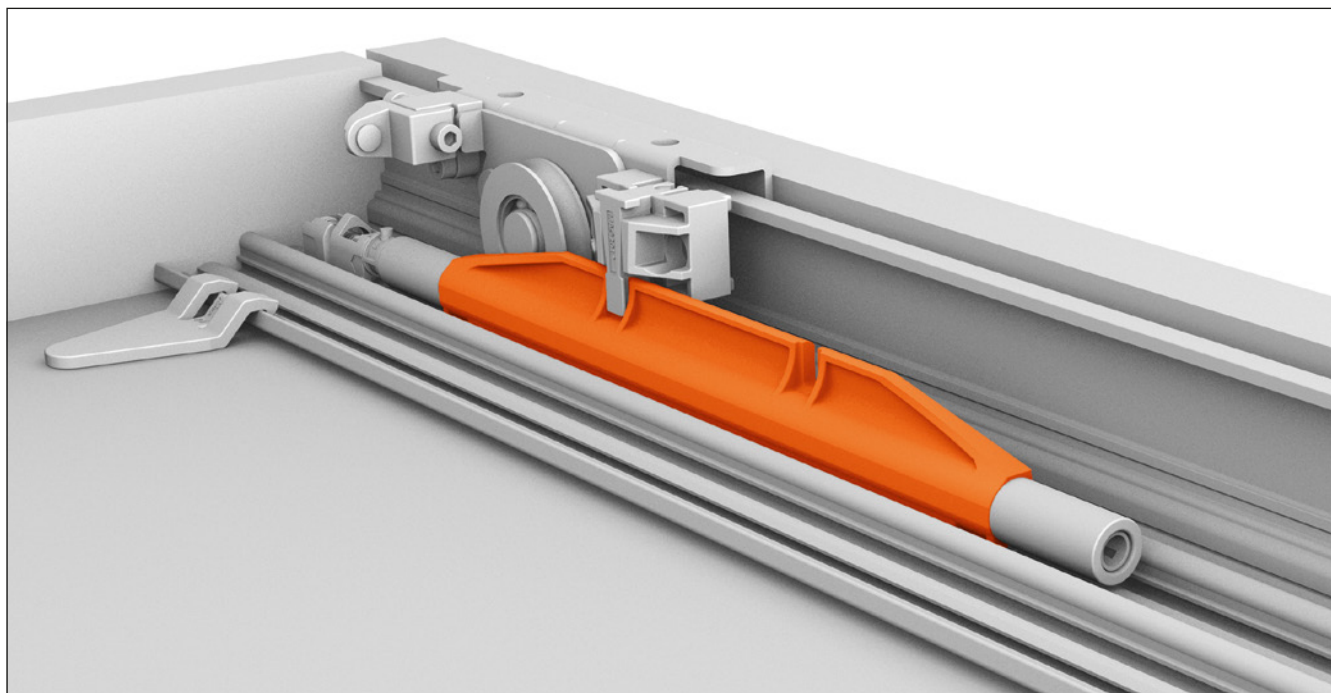

Arresti estremamente facili da montare e riposizionare.

Aggancio automatico, con riarmo, fra carrello e ammortizzatore.

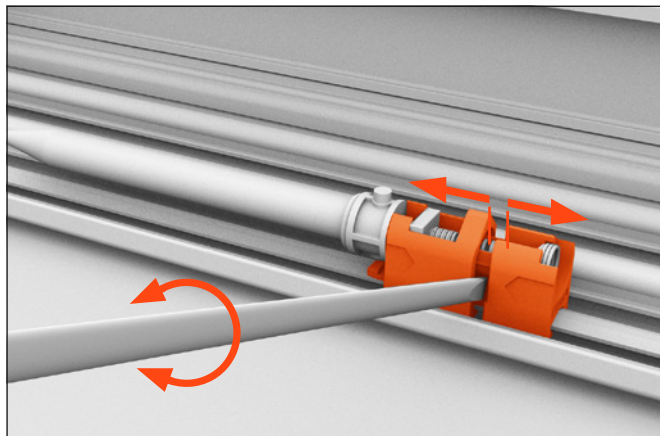

Copertura frontale del meccanismo con aggancio magnetico.

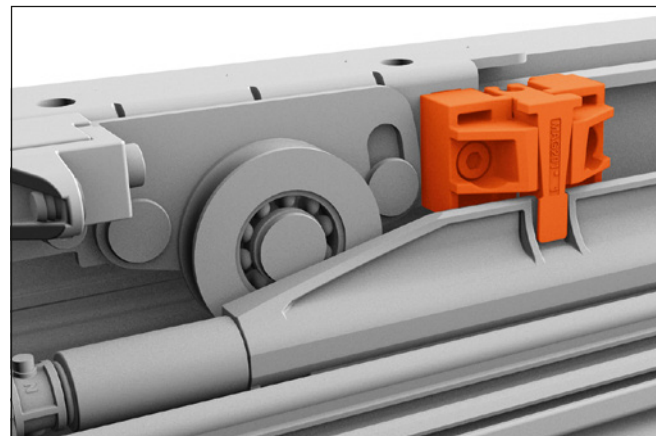

Installazione dei binari mediante clip con montaggio a pressione.

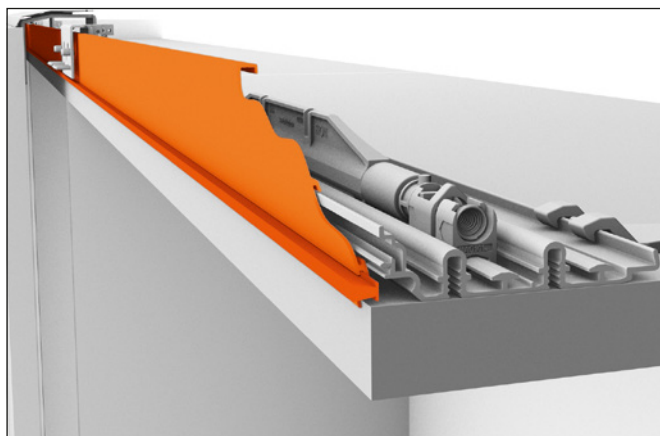

Glow Tipologie di montaggio

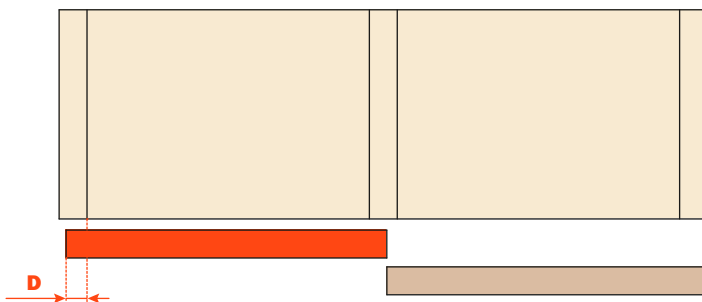
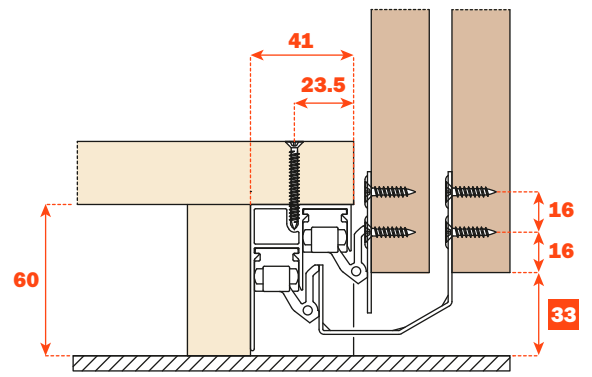
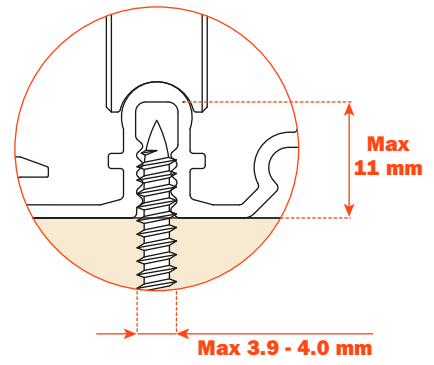
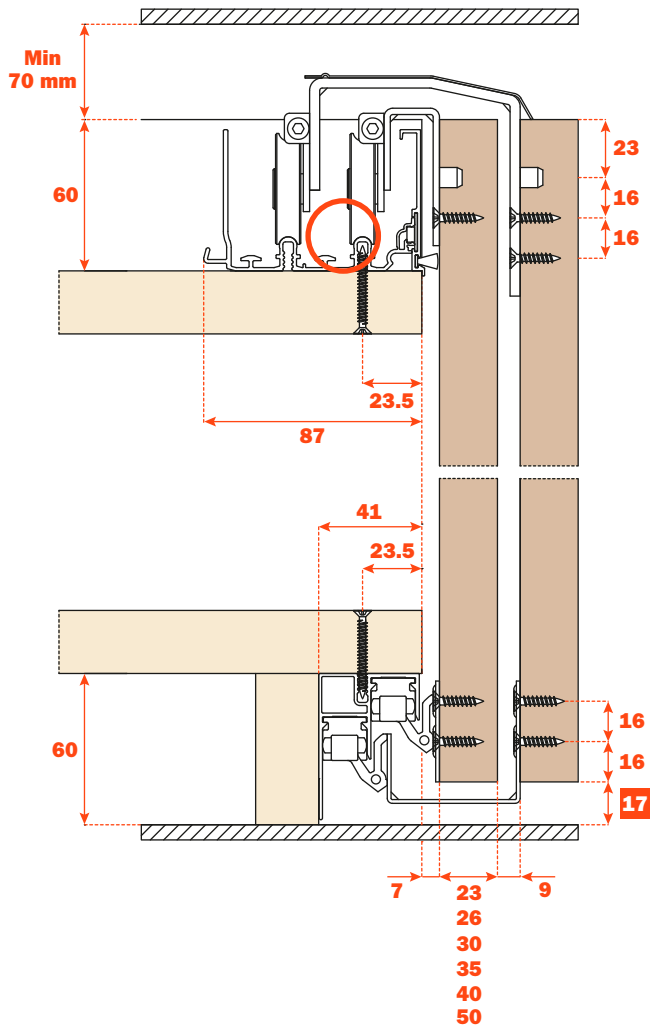

A min = D + 41 mm

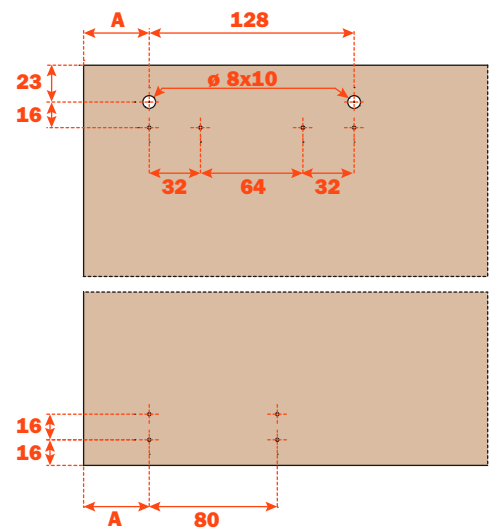

Klik

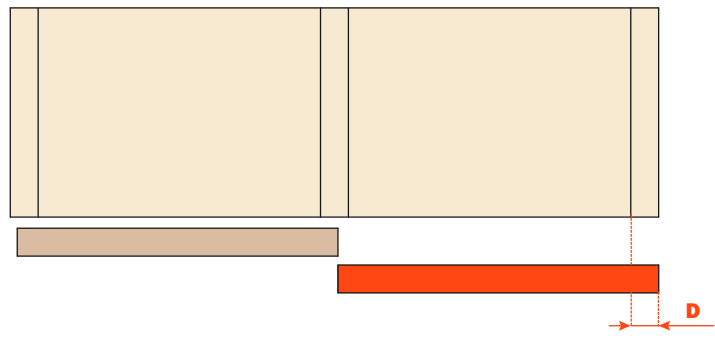
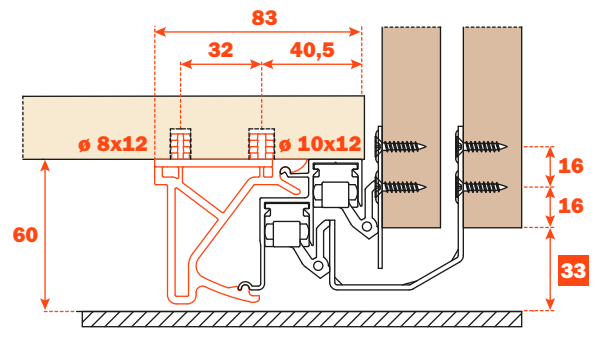
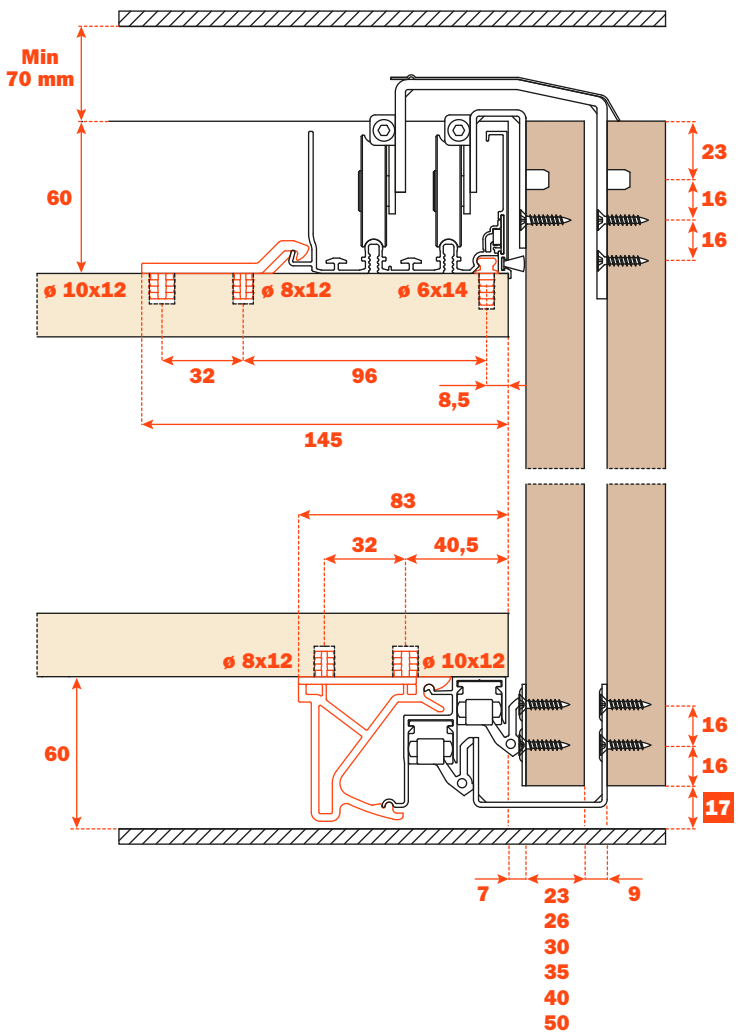



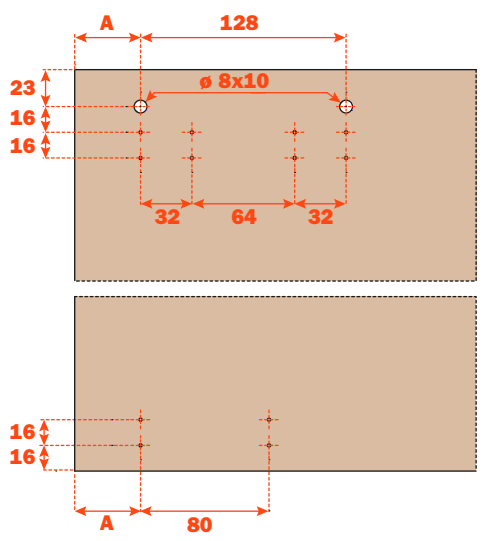















A min = D + 41 mm











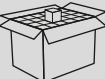

Glow Come ordinare confezioni per articolo

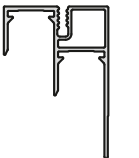
PROFILI

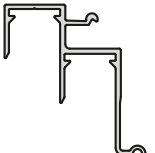





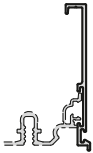
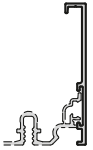

PROFILO SUPERIORE STANDARD	L	CODICE	 pezzi	 Kg	 mm	FISSAGGIO	
	mm						
Predisposto per copertura frontale	6200	VE41PIA16200AB	8	39,0	105 x 115 x 6300	Klik 	21152 
	3100	VE41PTA13100AB	8	19,6	105 x 115 x 3200	Klik 	
Non predisposto per copertura frontale	6200	VE41PIB16200AB	8	39,5	105 x 115 x 6300	Klik 	21151 
	3100	VE41PTB13100AB	8	19,8	105 x 115 x 3200	Klik 	

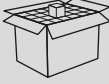
PROFILO SUPERIORE RINFORZATO	L	CODICE	 pezzi	 Kg	 mm	FISSAGGIO	
	mm						
Predisposto per copertura frontale	6200	VE41PIA26200AB	8	52,4	200 x 130 x 6300	Klik 	20944 
	3100	VE41PTA23100AB	8	26,2	200 x 130 x 3200	Klik 	
Non predisposto per copertura frontale	6200	VE41PIB26200AB	8	52,6	200 x 130 x 6300	Klik 	20573 
	3100	VE41PTB23100AB	8	26,3	200 x 130 x 3200	Klik 	

PROFILO INFERIORE	L	CODICE	 pezzi	 Kg	 mm	FISSAGGIO	
	mm						
	6200	VE41PIE16200AB	8	37,0	75 x 190 x 6300		21162 
	3100	VE41PTE13100AB	8	18,5	75 x 190 x 3200		
	6200	VE41BIX06200AB	8	35,8	235 x 75 x 6300	Klik	39428 
	3100	VE41BTX03100AB	8	17,9	235 x 75 x 3200	Klik	













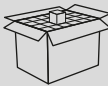

COPERTURA FRONTALE	L	CODICE	 pezzi	 Kg	 mm		
	mm						
Con sede per spazzolino	6200	VE41BIA06200AB	8	15,7	125 x 75 x 6300		34032 
	3100	VE41BTA03100AB	8	7,80	125 x 75 x 3200		
Senza sede per spazzolino	6200	VE41BIB06200AB	8	15,02	125 x 75 x 6300		35510 
	3100	VE41BTB03100AB	8	7,50	125 x 75 x 3200		













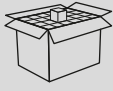



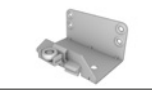

CARRELLI DI SCORRIMENTO ANTA INTERNA

ARTICOLO		CODICE	 pezzi	 Kg	 m ³	 mm	
	mm						
Carrello superiore destro		VE41KMCMi350DX0	30	13,0	0,016	445 x 191 x 190	
Carrello superiore sinistro		VE41KMCMi350SX0	30	13,0	0,016	445 x 191 x 190	
Carrello inferiore	17	VE41KMGLW310	30	2,9	0,008	295 x 292 x 100	
	33	VE41KMGLW320	30	3,6	0,008	295 x 292 x 100	

Glow + Come ordinare confezioni per articolo









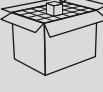

CARRELLI DI SCORRIMENTO ANTA ESTERNA

ARTICOLO	 mm	 mm	CODICE	 pezzi	 Kg	 m ³	 mm	
Carrello superiore destro	≤ 23		VE41KMCM1370DX0	30	30,0	0,038	460 x 460 x 180	
Carrello superiore sinistro	≤ 23		VE41KMCM1370SX0	30	30,0	0,038	460 x 460 x 180	
Carrello inferiore	≤ 23	17	VE41KMGLW311	30	6,3	0,011	330 x 310 x 110	
	≤ 23	33	VE41KMGLW321	30	6,8	0,011	330 x 310 x 110	
Carrello superiore destro	≤ 26		VE41KMCM1375DX0	30	30,5	0,038	460 x 460 x 180	
Carrello superiore sinistro	≤ 26		VE41KMCM1375SX0	30	30,5	0,038	460 x 460 x 180	
Carrello inferiore	≤ 26	17	VE41KMGLW316	30	6,5	0,011	330 x 310 x 110	
	≤ 26	33	VE41KMGLW326	30	6,9	0,011	330 x 310 x 110	

















ARTICOLO	 mm	 mm	CODICE	 pezzi	 Kg	 m ³	 mm	
Carrello superiore destro	≤ 30		VE41KMCMI371DX0	30	31,0	0,038	460 x 460 x 180	
Carrello superiore sinistro	≤ 30		VE41KMCMI371SX0	30	31,0	0,038	460 x 460 x 180	
Carrello inferiore	≤ 30	17	VE41KMGLW312	30	6,7	0,011	330 x 310 x 110	
	≤ 30	33	VE41KMGLW322	30	7,1	0,011	330 x 310 x 110	
Carrello superiore destro	≤ 35		VE41KMCMI372DX0	30	32,0	0,043	530 x 460 x 180	
Carrello superiore sinistro	≤ 35		VE41KMCMI372SX0	30	32,0	0,043	530 x 460 x 180	
Carrello inferiore	≤ 35	17	VE41KMGLW313	30	7,0	0,022	390 x 310 x 190	
	≤ 35	33	VE41KMGLW323	30	7,4	0,022	390 x 310 x 190	
Carrello superiore destro	≤ 40		VE41KMCMI374DX0	30	33,0	0,043	530 x 460 x 180	
Carrello superiore sinistro	≤ 40		VE41KMCMI374SX0	30	33,0	0,043	530 x 460 x 180	
Carrello inferiore	≤ 40	17	VE41KMGLW315	30	7,3	0,011	330 x 310 x 110	
	≤ 40	33	VE41KMGLW325	30	7,7	0,011	330 x 310 x 110	

Glow + Come ordinare confezioni per articolo

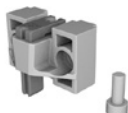

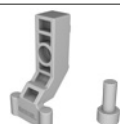







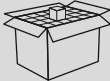

CARRELLI DI SCORRIMENTO ANTA ESTERNA

ARTICOLO	 mm	 mm	CODICE	 pezzi	 Kg	 m ³	 mm	
Carrello superiore destro	≤ 50		VE41KMCMi373DX0	30	34	0,043	530 x 460 x 180	
Carrello superiore sinistro	≤ 50		VE41KMCMi373SX0	30	34	0,043	530 x 460 x 180	
Carrello inferiore	≤ 50	17	VE41KMGLW314	30	7,7	0,022	390 x 310 x 110	
	≤ 50	33	VE41KMGLW324	30	8,1	0,022	390 x 310 x 110	

AMMORTIZZATORE E ARRESTI

ARTICOLO	CODICE	 pezzi	 Kg	 m ³	 mm	
Ammortizzatore magnetico 25 kg	VE41KMAMCMA0500	30	5,1	0,015	350 x 180 x 125	
Ammortizzatore magnetico 45 kg	VE41KMAMCMA1000	30	5,1	0,015	350 x 180 x 125	
Ammortizzatore magnetico 70 kg	VE41KMAMCMA2000	30	5,1	0,015	350 x 300 x 150	
Arresto per ammortizzatore magnetico 45 kg	VE41KMAMCMA5000	60	5,6	0,023	420 x 240 x 175	
Arresto per ammortizzatore magnetico 70 kg	VE41KMAMCMA5100	60	5,6	0,023	420 x 240 x 175	
Trascinatore per ammortizzatore magnetico	VE41KMAMCMA3000	30	0,7	0,005	240 x 200 x 100	
Fermo finale	VE41KMANCMI2000	60	2,4	0,003	140 x 140 x 140	
Attivatore per fermo finale	VE41KMANCMI3000	30	1,6	-	120 x 80 x 40	
Arresto inferiore	VE41KMGLW220	60	0,7	-	-	
Perno anticollisione	VE41KMGLW510	30	1,5	-	-	
Salvamaniglia	VE41KMGLW230	30	0,1	-	-	

ACCESSORI

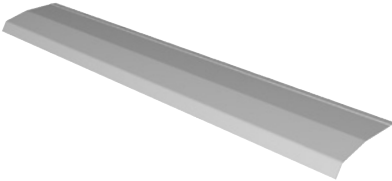
ARTICOLO	L	CODICE					
	mm		pezzi	Kg	m ³	mm	
Piolo Frontale		VE41MPGLW160	180	1,0	0,002	130 x 120 x 120	
Aggancio superiore		VE41MPGLW260	180	2,2	0,011	330 x 310 x 110	
Aggancio inferiore		VE41MPGLW270.0	180	4,5	0,023	480 x 280 x 175	
Applicatore aggancio inferiore		VE41MPGLW271.0	30	1,2	0,005	250 x 200 x 100	
Contropiastra		VE41MPGLW330	200	1,2	-	120 x 80 x 40	
Magnete 25x6		VE41MPMA250603	200	0,6	-	120 x 80 x 40	
Spazzolino H7 grigio		VE41MPPB4829	325 m	2,0	0,030	350 x 350 x 250	
Kit agganci antiscarrucolamento (Dx+Sx)		VE41MPGLW280	30	0,7	0,005	234 x 174 x 119	
Carter copri staffe anta esterna 	600	VE41CMVS00600A	10	4,3	0,003	100 x 50 x 600	
	700	VE41CMVS00700A	10	5,1	0,004	100 x 50 x 700	
	800	VE41CMVS00800A	10	5,8	0,004	100 x 50 x 800	
	900	VE41CMVS00900A	10	6,5	0,005	100 x 50 x 900	
	1000	VE41CMVS01000A	10	7,2	0,005	100 x 50 x 1000	
	1100	VE41CMVS01100A	10	7,9	0,006	100 x 50 x 1100	
	1200	VE41CMVS01200A	10	8,7	0,006	100 x 50 x 1200	
	1300	VE41CMVS01300A	10	9,4	0,007	100 x 50 x 1300	
	1400	VE41CMVS01400A	10	10,1	0,007	100 x 50 x 1400	
	1500	VE41CMVS01500A	10	10,8	0,008	100 x 50 x 1500	
	1600	VE41CMVS01600A	10	11,5	0,008	100 x 50 x 1600	
	1700	VE41CMVS01700A	10	12,3	0,009	100 x 50 x 1700	
	1800	VE41CMVS01800A	10	13,0	0,009	100 x 50 x 1800	
	1900	VE41CMVS01900A	10	13,7	0,010	100 x 50 x 1900	
2000	VE41CMVS02000A	10	14,4	0,010	100 x 50 x 2000		

ESEMPI COMPOSIZIONE CODICE

Esempio 1

Armadio 2 ante da 900 mm, spessore 30 mm, H da terra 17 mm, profilo standard, ammortizzatore, copertura frontale con spazzolino, profili di lunghezza 3100 mm.

1 x VE41PTA13100AB	1 x VE41KMCM1350SX0	2 x VE41KMGLW312	4 x VE41KMGLW220	2 x VE41MPPB4829
1 x VE41PTE13100AB	2 x VE41KMGLW310	2 x VE41KMAMCMA1000	1 x VE41KMGLW230	1 x VE41CMVS00900A
1 x VE41BTA03100AB	1 x VE41KMCM1371DX0	4 x VE41KMAMCMA5000	5 x VE41MPGLW330	
1 x VE41KMCM1350DX0	1 x VE41KMCM1371SX0	2 x VE41KMAMCMA3000	5 x VE41MPMA250603	

Esempio 2

Armadio 3 ante da 1200 mm, spessore 35 mm, H da terra 33 mm, profilo rinforzato, ammortizzatore, copertura frontale con spazzolino, profili di lunghezza 6200 mm.

1 x VE41PIA26200AB	2 x VE41KMCM1350SX0	2 x VE41KMGLW323	4 x VE41KMGLW220	4 x VE41MPPB4829
1 x VE41PIE16200AB	4 x VE41KMGLW320	3 x VE41KMAMCMA2000	2 x VE41KMGLW230	1 x VE41CMVS01200A
1 x VE41BIA06200AB	1 x VE41KMCM1372DX0	6 x VE41KMAMCMA5000	8 x VE41MPGLW330	
2 x VE41KMCM1350DX0	1 x VE41KMCM1372SX0	3 x VE41KMAMCMA3000	8 x VE41MPMA250603	

Esempio 3









Armadio 2 ante da 800 mm, spessore 23 mm, H da terra 17 mm, profilo standard, senza ammortizzatore e senza copertura frontale, profili di lunghezza 3100 mm.

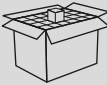







1 x VE41PTB13100AB	1 x VE41KMCM1350SX0	1 x VE41KMCM1370SX0	4 x VE41KMANCMI2000	1 x VE41KMGLW230
1 x VE41PTE13100AB	2 x VE41KMGLW310	2 x VE41KMGLW311	2 x VE41KMANCMI3000	1 x VE41CMVS00800A
1 x VE41KMCM1350DX0	1 x VE41KMCM1370DX0		4 x VE41KMGLW220	





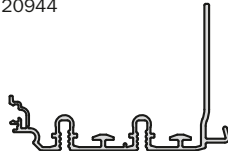

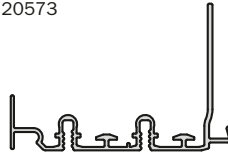
Negli esempi sono indicate le quantità necessarie per un armadio; per i quantitativi minimi di acquisto si rinvia alle tabelle precedenti.

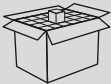

Glow Come ordinare confezioni kit per armadio

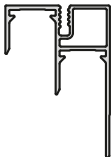

PROFILI

PROFILO SUPERIORE STANDARD	L	CODICE				FISSAGGIO	
	mm						
Predisposto per copertura frontale	6200	VE41PIA16200AB	8	39,0	105 x 115 x 6300	Klik 	21152 
	3100	VE41PTA13100AB	8	19,6	105 x 115 x 3200	Klik 	
Non predisposto per copertura frontale	6200	VE41PIB16200AB	8	39,5	105 x 115 x 6300	Klik 	21151 
	3100	VE41PTB13100AB	8	19,8	105 x 115 x 3200	Klik 	

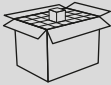
PROFILO SUPERIORE RINFORZATO	L	CODICE				FISSAGGIO	
	mm						
Predisposto per copertura frontale	6200	VE41PIA26200AB	8	52,4	200 x 130 x 6300	Klik 	20944 
	3100	VE41PTA23100AB	8	26,2	200 x 130 x 3200	Klik 	
Non predisposto per copertura frontale	6200	VE41PIB26200AB	8	52,6	200 x 130 x 6300	Klik 	20573 
	3100	VE41PTB23100AB	8	26,3	200 x 130 x 3200	Klik 	

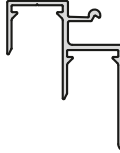

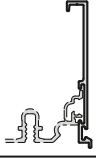
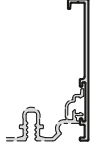

PROFILO INFERIORE	L	CODICE				FISSAGGIO	
	mm						
	6200	VE41PIE16200AB	8	37,0	75 x 190 x 6300		21162 
	3100	VE41PTE13100AB	8	18,5	75 x 190 x 3200		

PROFILO INFERIORE	L	CODICE				FISSAGGIO	
	mm						
	6200	VE41BIX06200AB	8	35,8	235 x 75 x 6300	Klik	39428 
	3100	VE41BTX03100AB	8	17,9	235 x 75 x 3200	Klik	

COPERTURA FRONTALE	L	CODICE				FISSAGGIO	
	mm						
Con sede per spazzolino	6200	VE41BIA06200AB	8	15,7	125 x 75 x 6300		34032 
	3100	VE41BTA03100AB	8	7,80	125 x 75 x 3200		
Senza sede per spazzolino	6200	VE41BIB06200AB	8	15,02	125 x 75 x 6300		35510 
	3100	VE41BTB03100AB	8	7,50	125 x 75 x 3200		

Glow Come ordinare confezioni kit per armadio

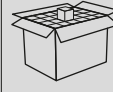
2 ANTE AMMORTIZZATO (25 KG)

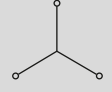
ARTICOLO			CODICE				
	mm	mm		pezzi	Kg	m ³	mm
Carrelli e ammortizzatori per armadio a 2 ante	≤ 23	17	VE41KSKACMA2013	1	4,52	0,013	330 x 230 x 170
	≤ 23	33	VE41KSKACMA2513	1	4,54	0,013	330 x 230 x 170
	≤ 26	17	VE41KSKACMA2063	1	4,56	0,013	330 x 230 x 170
	≤ 26	33	VE41KSKACMA2563	1	4,57	0,013	330 x 230 x 170
	≤ 30	17	VE41KSKACMA2023	1	4,59	0,013	330 x 230 x 170
	≤ 30	33	VE41KSKACMA2523	1	4,61	0,013	330 x 230 x 170
	≤ 35	17	VE41KSKACMA2033	1	4,65	0,014	340 x 240 x 175
	≤ 35	33	VE41KSKACMA2533	1	4,67	0,014	340 x 240 x 175
	≤ 40	17	VE41KSKACMA2043	1	4,71	0,014	340 x 240 x 180
	≤ 40	33	VE41KSKACMA2543	1	4,73	0,014	340 x 240 x 180
	≤ 50	17	VE41KSKACMA2053	1	4,89	0,015	340 x 240 x 190
	≤ 50	33	VE41KSKACMA2553	1	4,91	0,015	340 x 240 x 190

x 1

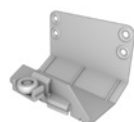
x 1

x 2

x 1

x 1

x 2

x 1

x 1

x 2

x 4

x 4

x 2

x 2





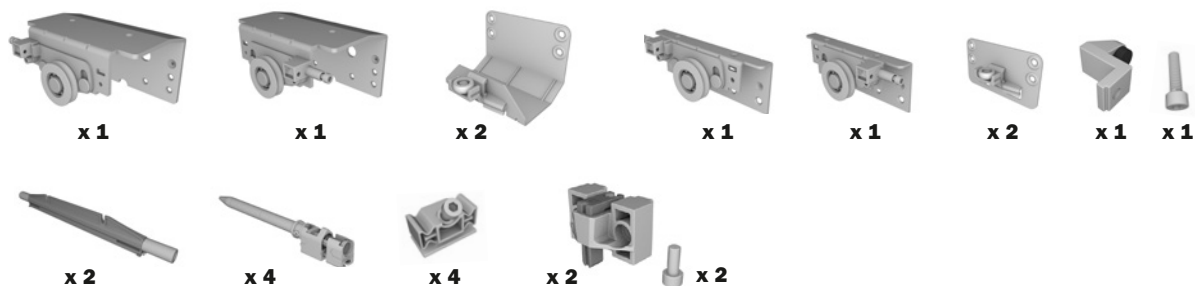

2 ANTE AMMORTIZZATO (45 KG)

ARTICOLO			CODICE				
	mm	mm		pezzi	Kg	m ³	mm
Carrelli e ammortizzatori per armadio a 2 ante	≤ 23	17	VE41KSKACMA2010	1	4,52	0,013	330 x 230 x 170
	≤ 23	33	VE41KSKACMA2510	1	4,54	0,013	330 x 230 x 170
	≤ 26	17	VE41KSKACMA2060	1	4,56	0,013	330 x 230 x 170
	≤ 26	33	VE41KSKACMA2560	1	4,57	0,013	330 x 230 x 170
	≤ 30	17	VE41KSKACMA2020	1	4,59	0,013	330 x 230 x 170
	≤ 30	33	VE41KSKACMA2520	1	4,61	0,013	330 x 230 x 170
	≤ 35	17	VE41KSKACMA2030	1	4,65	0,014	340 x 240 x 175
	≤ 35	33	VE41KSKACMA2530	1	4,67	0,014	340 x 240 x 175
	≤ 40	17	VE41KSKACMA2040	1	4,71	0,014	340 x 240 x 180
	≤ 40	33	VE41KSKACMA2540	1	4,73	0,014	340 x 240 x 180
	≤ 50	17	VE41KSKACMA2050	1	4,89	0,015	340 x 240 x 190
	≤ 50	33	VE41KSKACMA2550	1	4,91	0,015	340 x 240 x 190



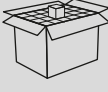



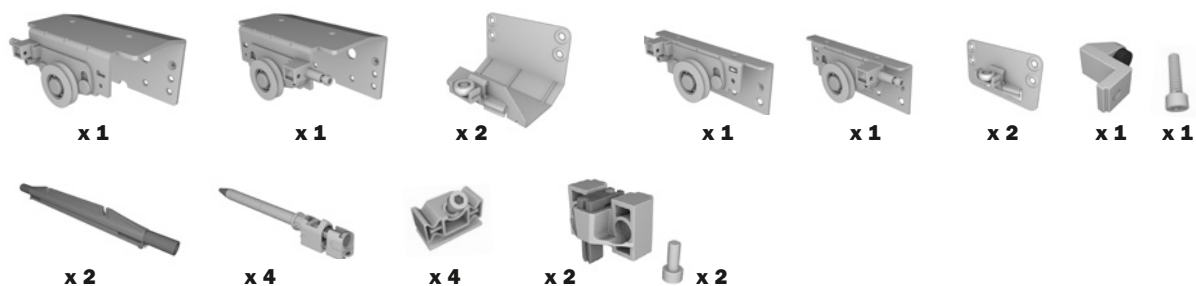

Glow Come ordinare confezioni kit per armadio

2 ANTE AMMORTIZZATO (70 KG)

ARTICOLO			CODICE				
	mm	mm		pezzi	Kg	m ³	mm
Carrelli e ammortizzatori per armadio a 2 ante	≤ 23	17	VE41KSKACMA2015	1	4,52	0,013	330 x 230 x 170
	≤ 23	33	VE41KSKACMA2515	1	4,54	0,013	330 x 230 x 170
	≤ 26	17	VE41KSKACMA2065	1	4,56	0,013	330 x 230 x 170
	≤ 26	33	VE41KSKACMA2565	1	4,57	0,013	330 x 230 x 170
	≤ 30	17	VE41KSKACMA2025	1	4,59	0,013	330 x 230 x 170
	≤ 30	33	VE41KSKACMA2525	1	4,61	0,013	330 x 230 x 170
	≤ 35	17	VE41KSKACMA2035	1	4,65	0,014	340 x 240 x 175
	≤ 35	33	VE41KSKACMA2535	1	4,67	0,014	340 x 240 x 175
	≤ 40	17	VE41KSKACMA2045	1	4,71	0,014	340 x 240 x 180
	≤ 40	33	VE41KSKACMA2545	1	4,73	0,014	340 x 240 x 180
	≤ 50	17	VE41KSKACMA2055	1	4,89	0,015	340 x 240 x 190
	≤ 50	33	VE41KSKACMA2555	1	4,91	0,015	340 x 240 x 190







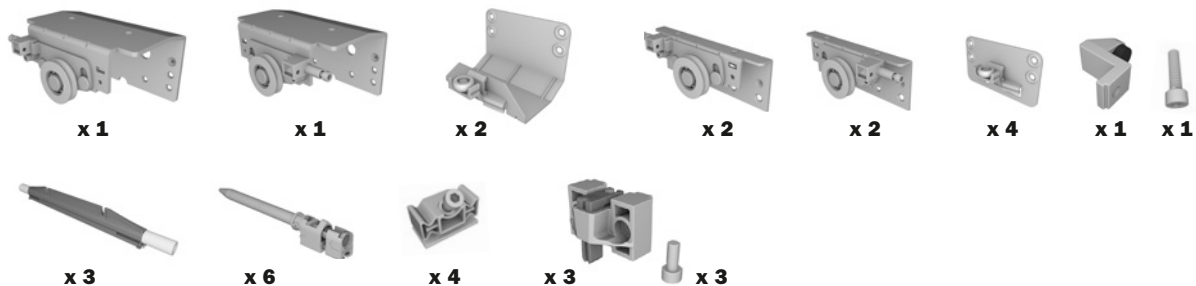

3 ANTE AMMORTIZZATO (25 KG)

ARTICOLO			CODICE				
	mm	mm		pezzi	Kg	m ³	mm
Carrelli e ammortizzatori per armadio a 3 ante	≤ 23	17	VE41KSKACMA3013	1	6,02	0,013	330 x 230 x 170
	≤ 23	33	VE41KSKACMA3513	1	6,06	0,013	330 x 230 x 170
	≤ 26	17	VE41KSKACMA3063	1	6,05	0,013	330 x 230 x 170
	≤ 26	33	VE41KSKACMA3563	1	6,08	0,013	330 x 230 x 170
	≤ 30	17	VE41KSKACMA3023	1	6,09	0,013	330 x 230 x 170
	≤ 30	33	VE41KSKACMA3523	1	6,13	0,013	330 x 230 x 170
	≤ 35	17	VE41KSKACMA3033	1	6,15	0,014	340 x 240 x 175
	≤ 35	33	VE41KSKACMA3533	1	6,19	0,014	340 x 240 x 175
	≤ 40	17	VE41KSKACMA3043	1	6,21	0,014	340 x 240 x 180
	≤ 40	33	VE41KSKACMA3543	1	6,25	0,014	340 x 240 x 180
	≤ 50	17	VE41KSKACMA3053	1	6,39	0,015	340 x 240 x 190
	≤ 50	33	VE41KSKACMA3553	1	6,43	0,015	340 x 240 x 190



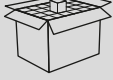



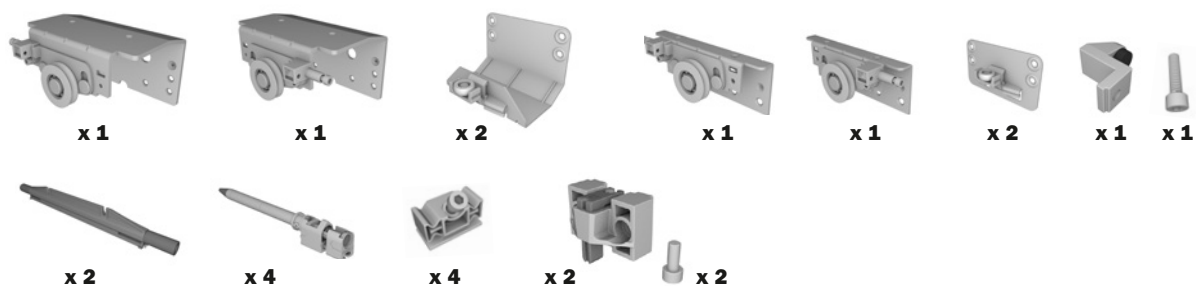

Glow+ Come ordinare confezioni kit per armadio

3 ANTE AMMORTIZZATO (45 KG)

ARTICOLO			CODICE				
	mm	mm		pezzi	Kg	m ²	mm
Carrelli e ammortizzatori per armadio a 3 ante	≤ 23	17	VE41KSKACMA3010	1	6,02	0,013	330 x 230 x 170
	≤ 23	33	VE41KSKACMA3510	1	6,06	0,013	330 x 230 x 170
	≤ 26	17	VE41KSKACMA3060	1	6,05	0,013	330 x 230 x 170
	≤ 26	33	VE41KSKACMA3560	1	6,08	0,013	330 x 230 x 170
	≤ 30	17	VE41KSKACMA3020	1	6,09	0,013	330 x 230 x 170
	≤ 30	33	VE41KSKACMA3520	1	6,13	0,013	330 x 230 x 170
	≤ 35	17	VE41KSKACMA3030	1	6,15	0,014	340 x 240 x 175
	≤ 35	33	VE41KSKACMA3530	1	6,19	0,014	340 x 240 x 175
	≤ 40	17	VE41KSKACMA3040	1	6,21	0,014	340 x 240 x 180
	≤ 40	33	VE41KSKACMA3540	1	6,25	0,014	340 x 240 x 180
	≤ 50	17	VE41KSKACMA3050	1	6,39	0,015	340 x 240 x 190
	≤ 50	33	VE41KSKACMA3550	1	6,43	0,015	340 x 240 x 190

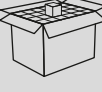





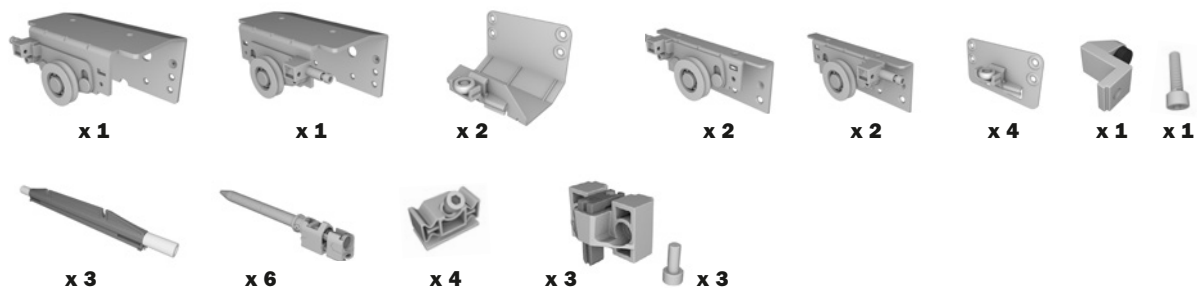

3 ANTE AMMORTIZZATO (70 KG)

ARTICOLO			CODICE				
	mm	mm		pezzi	Kg	m ³	mm
Carrelli e ammortizzatori per armadio a 3 ante	≤ 23	17	VE41KSKACMA3015	1	6,02	0,013	330 x 230 x 170
	≤ 23	33	VE41KSKACMA3515	1	6,06	0,013	330 x 230 x 170
	≤ 26	17	VE41KSKACMA3065	1	6,05	0,013	330 x 230 x 170
	≤ 26	33	VE41KSKACMA3565	1	6,08	0,013	330 x 230 x 170
	≤ 30	17	VE41KSKACMA3025	1	6,09	0,013	330 x 230 x 170
	≤ 30	33	VE41KSKACMA3525	1	6,13	0,013	330 x 230 x 170
	≤ 35	17	VE41KSKACMA3035	1	6,15	0,014	340 x 240 x 175
	≤ 35	33	VE41KSKACMA3535	1	6,19	0,014	340 x 240 x 175
	≤ 40	17	VE41KSKACMA3045	1	6,21	0,014	340 x 240 x 180
	≤ 40	33	VE41KSKACMA3545	1	6,25	0,014	340 x 240 x 180
	≤ 50	17	VE41KSKACMA3055	1	6,39	0,015	340 x 240 x 190
	≤ 50	33	VE41KSKACMA3555	1	6,43	0,015	340 x 240 x 190



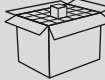





Glow Come ordinare confezioni kit per armadio

2 ANTE NON AMMORTIZZATO

ARTICOLO			CODICE				
	mm	mm		pezzi	Kg	m ³	mm
Carrelli e arresti per armadio a 2 ante	≤ 23	17	VE41KSNACMI2010	1	3,86	0,009	330 x 230 x 120
	≤ 23	33	VE41KSNACMI2510	1	3,88	0,009	330 x 230 x 120
	≤ 26	17	VE41KSNACMI2060	1	3,89	0,009	330 x 230 x 120
	≤ 26	33	VE41KSNACMI2560	1	3,92	0,009	330 x 230 x 120
	≤ 30	17	VE41KSNACMI2020	1	3,93	0,009	330 x 230 x 120
	≤ 30	33	VE41KSNACMI2520	1	3,95	0,009	330 x 230 x 120
	≤ 35	17	VE41KSNACMI2030	1	3,99	0,010	340 x 240 x 125
	≤ 35	33	VE41KSNACMI2530	1	4,01	0,010	340 x 240 x 125
	≤ 40	17	VE41KSNACMI2040	1	4,05	0,011	340 x 240 x 130
	≤ 40	33	VE41KSNACMI2540	1	4,07	0,011	340 x 240 x 130
	≤ 50	17	VE41KSNACMI2050	1	4,23	0,011	340 x 240 x 140
	≤ 50	33	VE41KSNACMI2550	1	4,25	0,011	340 x 240 x 140



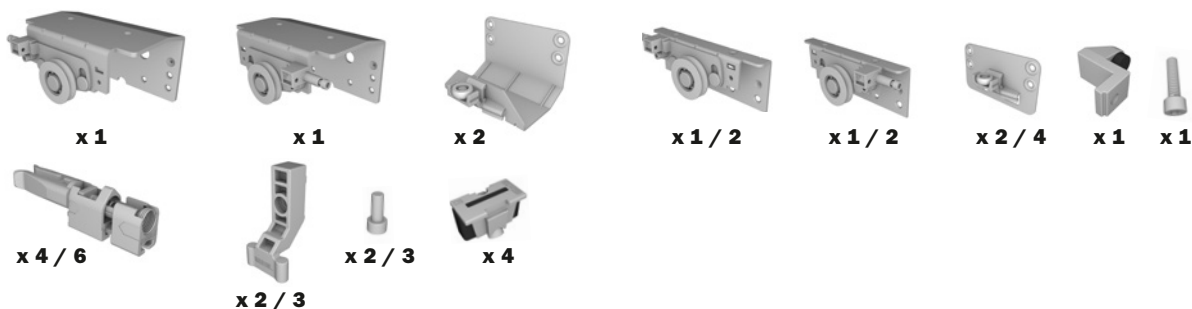

3 ANTE NON AMMORTIZZATO

ARTICOLO			CODICE				
	mm	mm		pezzi	Kg	m ³	mm
Carrelli e arresti per armadio a 3 ante	≤ 23	17	VE41KSNACMI3010	1	4,04	0,009	330 x 230 x 120
	≤ 23	33	VE41KSNACMI3510	1	4,24	0,009	330 x 230 x 120
	≤ 26	17	VE41KSNACMI3060	1	4,06	0,009	330 x 230 x 120
	≤ 26	33	VE41KSNACMI3560	1	4,28	0,009	330 x 230 x 120
	≤ 30	17	VE41KSNACMI3020	1	4,11	0,009	330 x 230 x 120
	≤ 30	33	VE41KSNACMI3520	1	4,31	0,009	330 x 230 x 120
	≤ 35	17	VE41KSNACMI3030	1	4,17	0,010	340 x 240 x 125
	≤ 35	33	VE41KSNACMI3530	1	4,37	0,010	340 x 240 x 125
	≤ 40	17	VE41KSNACMI3040	1	4,23	0,011	340 x 240 x 130
	≤ 40	33	VE41KSNACMI3540	1	4,43	0,011	340 x 240 x 130
	≤ 50	17	VE41KSNACMI3050	1	4,41	0,011	340 x 240 x 140
	≤ 50	33	VE41KSNACMI3550	1	4,61	0,011	340 x 240 x 140



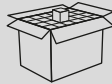

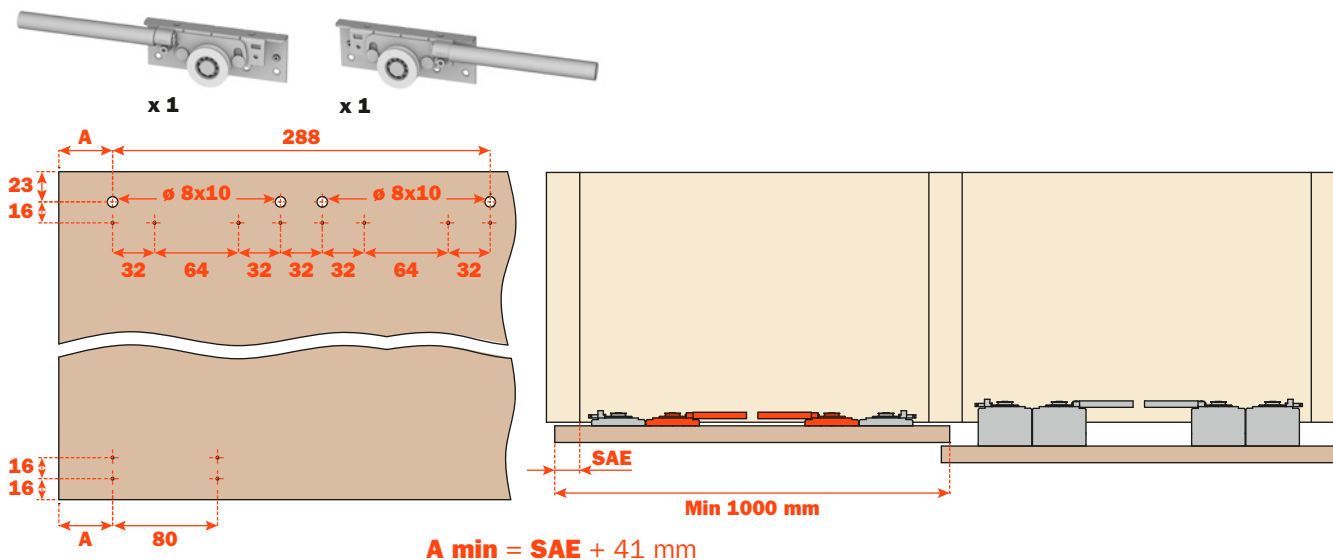

KIT CARRELLI 100 KG

Coppia di carrelli, che aggiunti a quelli standard, aumentano la portata dell'anta fino ad un massimo di 100 kg.

ARTICOLO		CODICE	 pezzi	 Kg	 m ³	 mm
Carrelli per anta interna		VE41KSKPCMI1A99	1	1,2	0,011	340 x 240 x 136





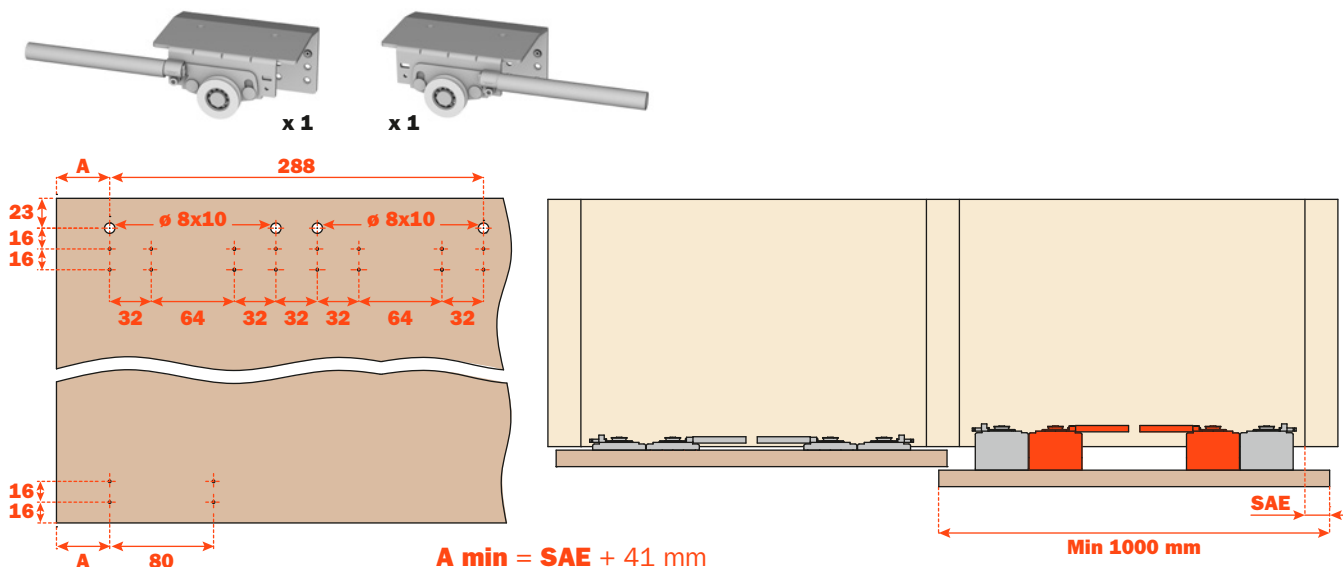

ARTICOLO	 mm	CODICE	 pezzi	 Kg	 m ³	 mm
Carrelli per anta esterna	23	VE41KSKPCMI1A19	1	2,2	0,011	340 x 240 x 136
	26	VE41KSKPCMI1A69	1	2,3	0,011	340 x 240 x 136
	30	VE41KSKPCMI1A29	1	2,3	0,011	340 x 240 x 136
	35	VE41KSKPCMI1A39	1	2,4	0,011	340 x 240 x 136
	40	VE41KSKPCMI1A49	1	2,5	0,011	340 x 240 x 136
	50	VE41KSKPCMI1A59	1	2,6	0,011	340 x 240 x 136



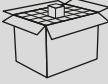

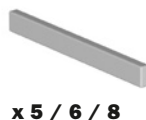
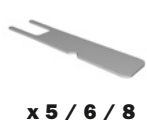

Glow Come ordinare confezioni kit per armadio

KIT ACCESSORI PER COPERTURA FRONTALE

ARTICOLO	L	CODICE	 pezzi	 Kg	 m ³	 mm
	mm					
Kit magneti, contropiastre e spazzolino	≤ 2000	VE41KSM0S05	1	0,10	-	120 x 80 x 4
	≤ 3000	VE41KSM0S06	1	0,12	-	120 x 80 x 4
	≤ 4000	VE41KSM0S07	1	0,14	-	120 x 80 x 4



KIT CLIP

ARTICOLO		CODICE	 pezzi	 Kg	 m ³	 mm
Kit 6 agganci con applicatore		VE41KSCCLIP6	1	0,26	-	-
Kit 9 agganci con applicatore		VE41KSCCLIP9	1	0,37	-	-

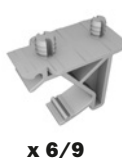



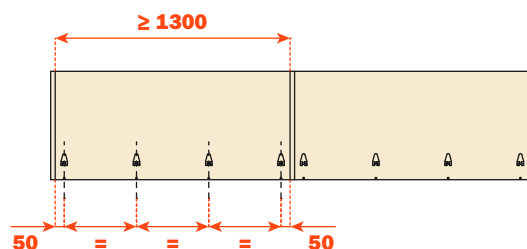
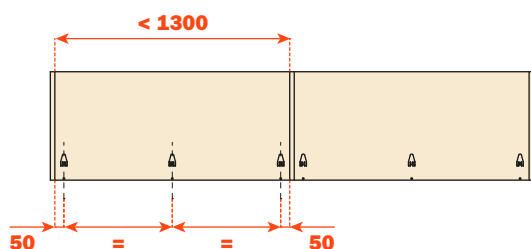

Klik

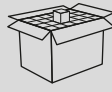

KIT PERNI ANTICOLLISIONE



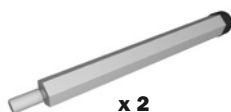

Per gli armadi a 3 ante, è possibile ordinare i perni anticollisione da applicare alle ante interne (1 kit da 2 pezzi).

ARTICOLO	CODICE	 pezzi	 Kg	 m ³	 mm
Perni anticollisione	VE41KMGLW510C	1	0,05	-	-

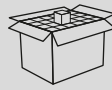

x 2

CARTER PARAPOLVERE CON VELCRO AUTOADESIVO

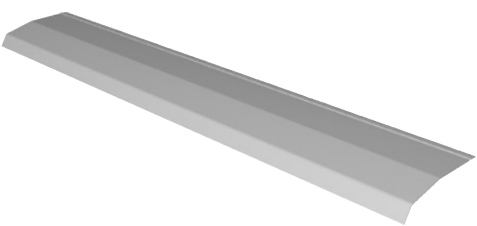
ARTICOLO	L	CODICE	 pezzi	 Kg	 m ³	 mm
	 mm					
Carter copri staffe anta esterna 	600	VE41CSVS00600A	1	0,31	0,003	900 x 110 x 30
	700	VE41CSVS00700A	1	0,33	0,003	900 x 110 x 30
	800	VE41CSVS00800A	1	0,35	0,003	900 x 110 x 30
	900	VE41CSVS00900A	1	0,38	0,003	900 x 110 x 30
	1000	VE41CSVS01000A	1	0,45	0,004	1200 x 110 x 30
	1100	VE41CSVS01100A	1	0,48	0,004	1200 x 110 x 30
	1200	VE41CSVS01200A	1	0,50	0,004	1200 x 110 x 30
	1300	VE41CSVS01300A	1	0,52	0,005	1500 x 110 x 30
	1400	VE41CSVS01400A	1	0,55	0,005	1500 x 110 x 30
	1500	VE41CSVS01500A	1	0,63	0,006	1500 x 110 x 30
	1600	VE41CSVS01600A	1	0,66	0,006	2000 x 110 x 30
	1700	VE41CSVS01700A	1	0,68	0,006	2000 x 110 x 30
	1800	VE41CSVS01800A	1	0,70	0,006	2000 x 110 x 30
	1900	VE41CSVS01900A	1	0,72	0,006	2000 x 110 x 30
2000	VE41CSVS02000A	1	0,85	0,006	2000 x 110 x 30	

Glow + Come ordinare confezioni kit per armadio**ESEMPI COMPOSIZIONE CODICE****Esempio 1**

Armadio 2 ante (70 kg) da 900 mm, spessore 30 mm, H da terra 17 mm, profilo standard, ammortizzatore, copertura frontale con spazzolino, profili di lunghezza 3100 mm.

1 x VE41PTA13100AB	1 x VE41PTA13100AB
1 x VE41PTE13100AB	1 x VE41PTE13100AB
1 x VE41BTA03100AB	1 x VE41BTA03100AB
	1 x VE41KSM0S05
	1 x VE41CSVS00900A
	1 x VE41KSKACMA2025

Esempio 2

Armadio 3 ante (45 kg) da 1200 mm, spessore 35 mm, H da terra 33 mm, profilo rinforzato, ammortizzatore, copertura frontale con spazzolino, profili di lunghezza 6200 mm.

1 x VE41PIA26200AB	1 x VE41KSM0S07
1 x VE41PIE16200AB	1 x VE41CSVS01200A
1 x VE41BIA06200AB	1 x VE41KSKACMA3530

Esempio 3

Armadio 3 ante da 1200 mm, spessore 50 mm, H da terra 33 mm, profilo standard, senza ammortizzatore e copertura frontale senza spazzolino, profili di lunghezza 6200 mm.

1 x VE41PIA16200AB	1 x VE41KSM0S07
1 x VE41BIA06200AB	1 x VE41CSVS01200A
1 x VE41BIB06200AB	1 x VE41KSNACMI3550

Negli esempi sono indicate le quantità necessarie per un armadio; per i quantitativi minimi di acquisto si rinvia alle tabelle precedenti.

Montaggio dei carrelli

ANTE INTERNE

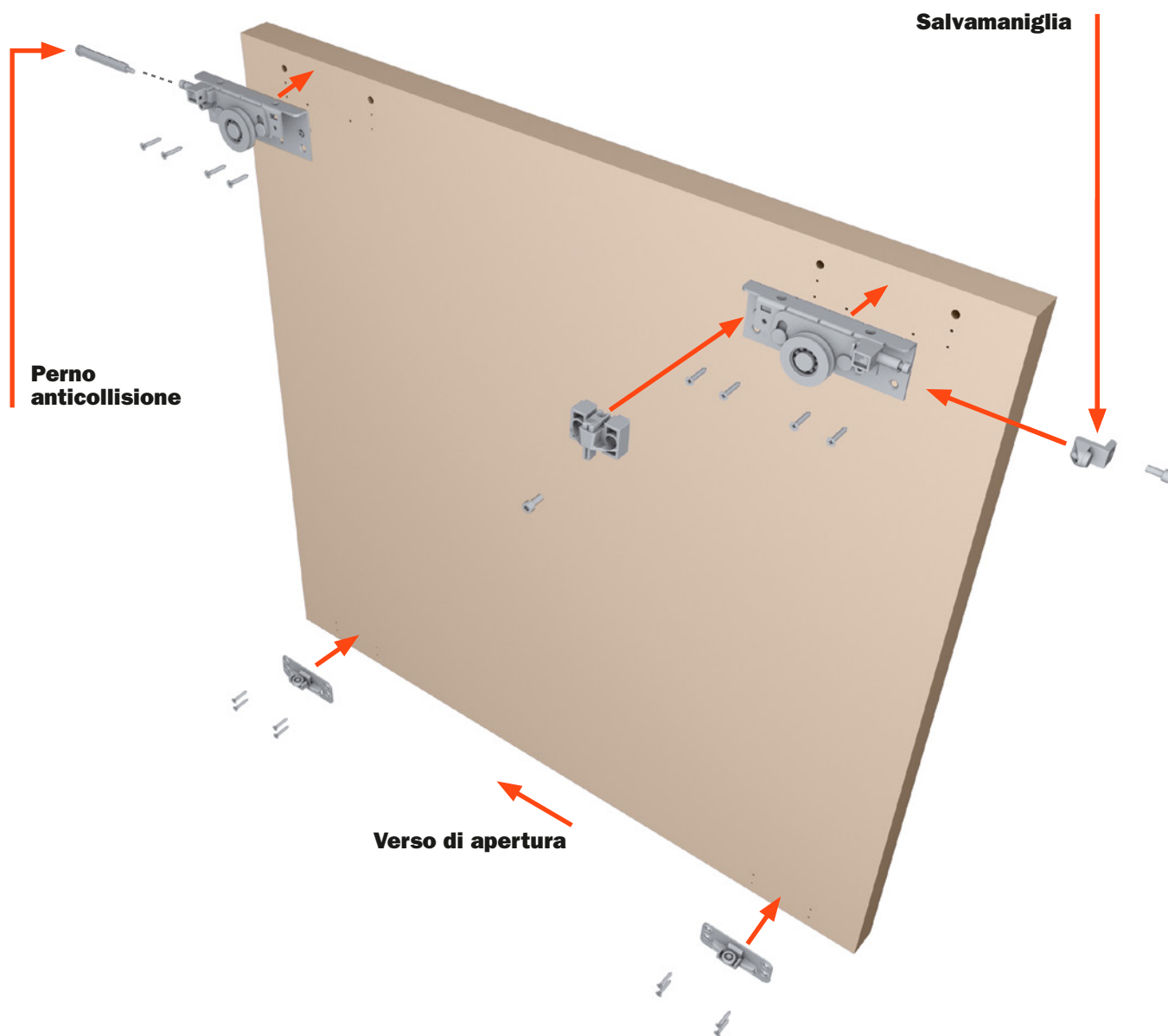

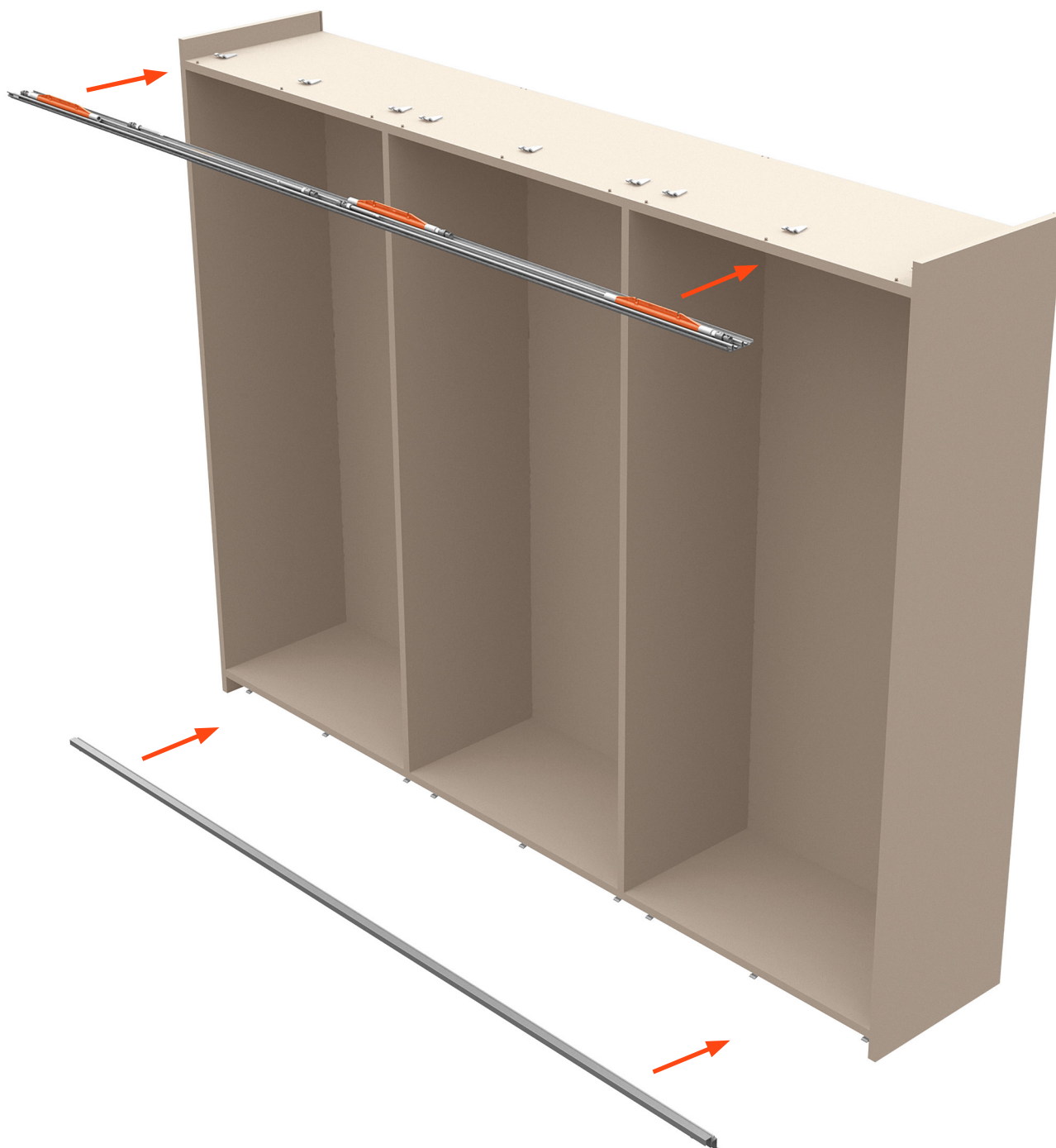
Montaggio del meccanismo**BREVETTI**

Brevetto depositato presso il Ministero delle Attività Produttive Ufficio Italiano Brevetti e Marchi (U.I.B.M.).

ARTURO SALICE S.p.A.

VIA PROVINCIALE NOVEDRATESE, 10
22060 NOVEDRATE (COMO) ITALIA
TEL. 031 790424 - FAX 031 791508
info.salice@salice.com - www.salice.com

DEUTSCHE SALICE GMBH

RUDOLF DIESEL STR. 10
POSTFACH 1154
74382 NECKARWESTHEIM
TEL. 07233 9807-0
FAX. 07233 9807-16
info.salice@deutschesalice.de
www.salice.com

DEUTSCHE SALICE GMBH

VERKAUFSBÜRO NORD
RINGSTRASSE 36/A30 CENTER
32584 LÖHNE
TEL. 05731 15608-0
FAX. 05731 15608-10
vknord@deutschesalice.de
www.salice.com

SALICE UK LTD.

KINGFISHER WAY
HINCHINGBROOKE BUSINESS PARK
HUNTINGDON CAMBS PE 29 6FN
TEL. 01480 413831
FAX. 01480 451489
info.salice@saliceuk.co.uk
www.salice.com

BORTOLUZZI SISTEMI S.p.A.

VIA CADUTI 14 SETTEMBRE 1944, 45
32100 BELLUNO ITALIA
TEL. 0437 930866 - FAX 0437 931442
info@bortoluzzi.com - www.bortoluzzi.com

SALICE FRANCE S.A.R.L.

ROUTE DE GOA ZAC LES 3 MOULINS
06600 ANTIBES
TEL. 0493 330069
FAX. 0493 330141
info.salice@salicefrance.com
www.salice.com

SALICE ESPAÑA, S.L.U.

CALLE COPÉRNICO, 11
POLÍGONO INDUSTRIAL COLL DE LA MANYA
08403 GRANOLLERS (BARCELONA)
TEL. 938 45 88 61
FAX 938 49 11 97
info.salice@saliceespana.es
www.salice.com

SALICE PORTUGAL UNIP. LDA

VIA ROTA DOS MÓVEIS I n.399
4585-325 GANDRA-PAREDES (DISTRITO PORTO)
TEL. 00351 224 154 221
info@saliceportugal.pt
www.salice.com

SALICE CHINA (SHANGHAI) CO. LTD.

1st FLOOR, B1 BLDG 928 MINGZHU ROAD
XUJING, QINGPU DISTRICT
SHANGHAI 201702 - CHINA
TEL. 021 3988 9880
FAX. 021 3988 9882
info.salice@salicechina.com
www.salicechina.com

SALICE INDIA PVT. LTD.

1001 & 1002, 10TH FLOOR,
CENTRUM, PLOT NO. C-3,
OPP. WAGLE PRABHAG SAMITI OFFICE,
MIDC AREA, WAGLE INDUSTRIAL ESTATE,
THANE - 400604, MAHARASHTRA
TEL. 022 20812050
info@saliceindia.com
www.salice.com

SALICE CANADA INC.

3500 RIDGEWAY DRIVE,
UNIT#1
MISSISSAUGA, ONTARIO, L5L 0B4
TEL. 905 8208787
FAX. 905 8207226
info.salice@salicecanada.com
www.salicecanada.com

SALICE AMERICA INC.

2123 CROWN CENTRE DRIVE
CHARLOTTE NC. 28227
TEL. 704 8417810
FAX. 704 8417808
info.salice@saliceamerica.com
www.saliceamerica.com



Contenuti digitali

Ci riserviamo il diritto di modificare le specifiche tecniche.



DOCASS004ITA Ed. 04 - 12/2021